

TECHNICAL DATA

Three Phase Electric Motors - Aluminum Frame
UMHA 80G-2 IE2
1.1 kW / 1.5 Cv
2840 RPM

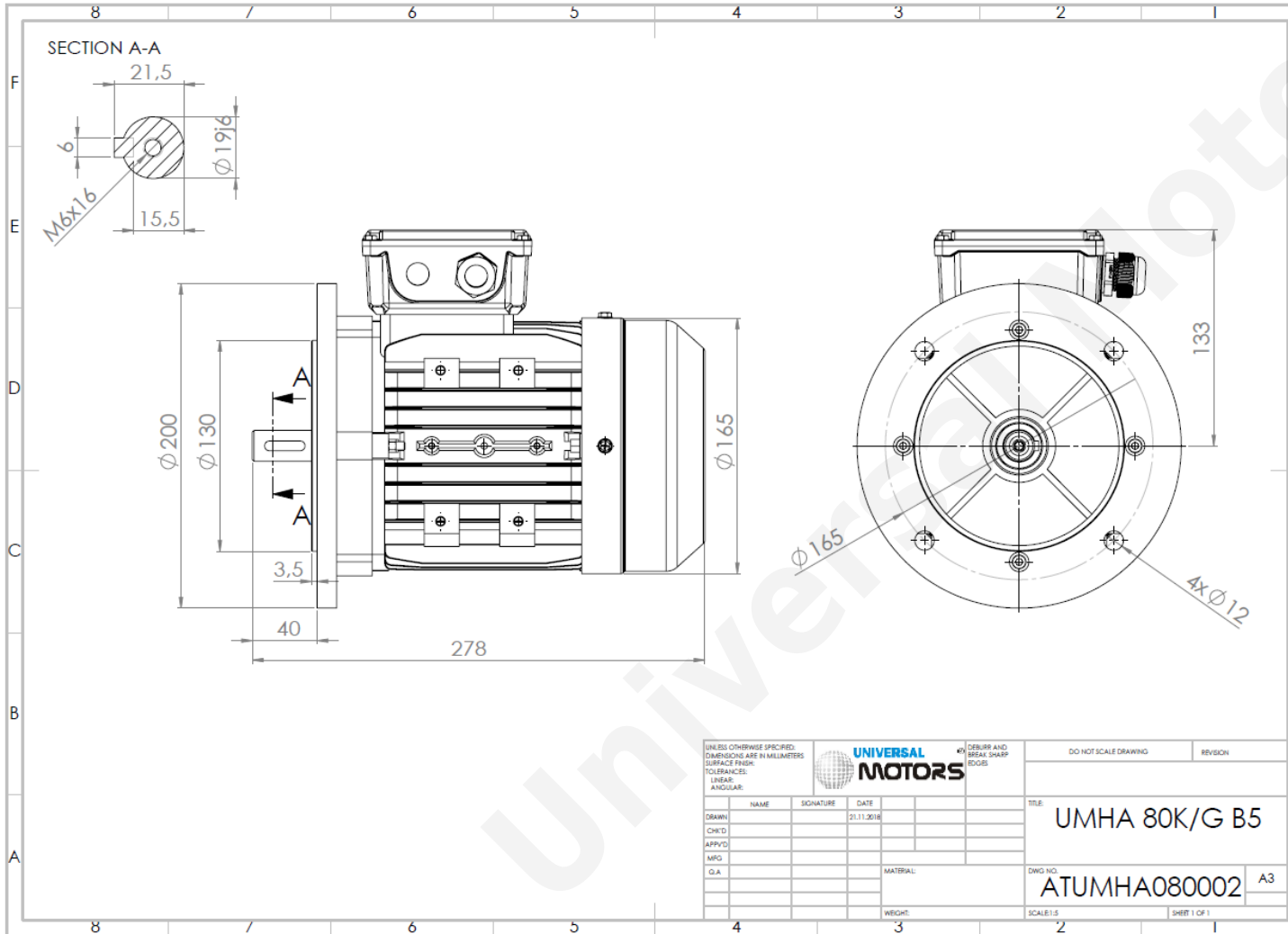

Motor type:	UMHA 80G-2 IE2
Output:	1.1 kW / 1.5 Cv
Speed (min ⁻¹):	2840 RPM
Voltage:	400 V
Frequency:	50 Hz
Current:	2.4 A
Power factor (Cos Ø):	0.83
Poles:	2
Insulation class:	F
Temperature rise Class:	B
Efficiency 50%:	79.0 %
Efficiency 75%:	80.1 %
Efficiency 100%:	79.6 %
Torque:	3.70 N.m
Tstarting/Tnominal:	2.3
Istarting/Inominal:	7.3
Tmaximum/Tnominal:	2.3
Noise:	74 Db(A)
Weight:	11.0 Kg
Bearing DE:	6204 2Z C3
Bearing NDE:	6204 2Z C3

Regime - S1

Altitude - 1000m

Environment Temperature - 40°C

CONTACTS:

Universal Motors UK, Ltd
Unit E2, Meltham Mills Industrial Estate, Meltham Mills Road, Meltham, Holmfirth
West Yorkshire HD9 4AR, U.K

Tel: +44(0) 1484 660 222

Fax: +44(0) 1484 660 333

Mail: enquiries@universalmotors-group.co.uk

* References applied only in the UK